

**FLOOR-EQUIPMENT-PARTS.COM**

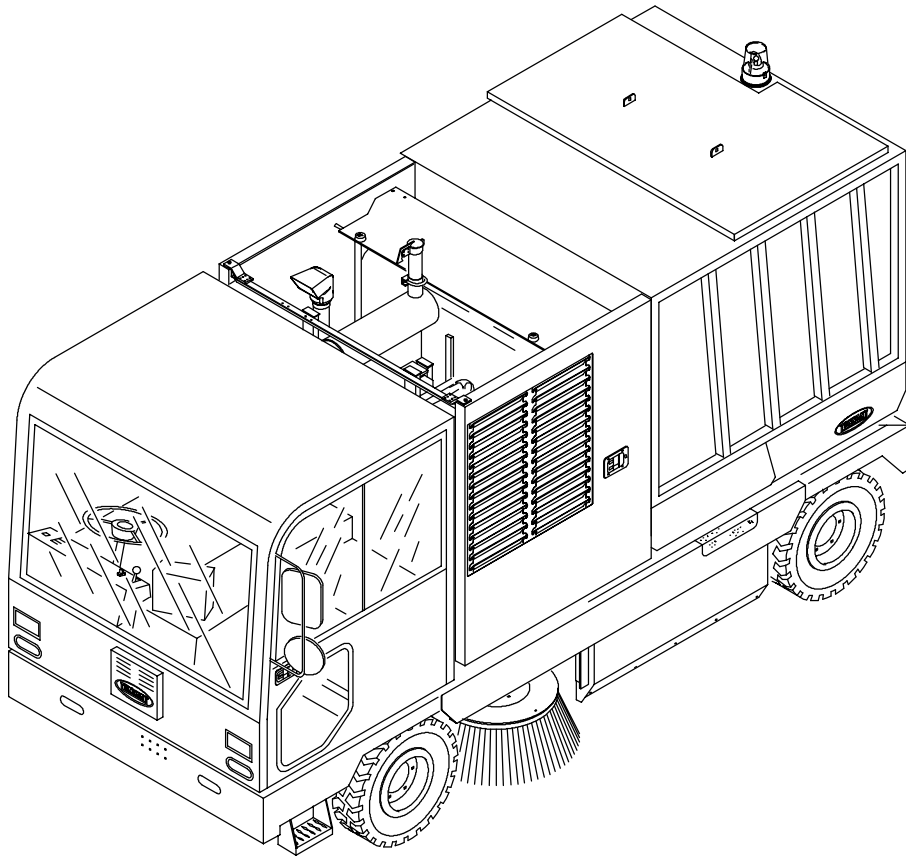

**830-II**

**Cummins 6 Cylinder Engine Breakdown**



**330493**

**Rev. 01**





This manual is furnished with each new TENNANT Model 830.

This manual consists of the *6 Cylinder Engine Breakdown*.

**MACHINE DATA**

*Please fill out at time of installation for future reference.*

Machine Model Number - 830-II

Machine Serial Number - \_\_\_\_\_

Machine Options - \_\_\_\_\_

TENNANT Representative/phone no. - \_\_\_\_\_

Customer ID Number - \_\_\_\_\_

Date of Installation - \_\_\_\_\_

Manual Number - 330493

Revision: 01

Published: 12-02

SECTION 8

CONTENTS	PAGE
Fig. 1 - Cummins 6 Cyl. General Recommended Maintenance Items .....	8-3
Fig. 2 - Cummins 6 Cyl. Engine Group .....	8-4
Fig. 3 - Cummins 6 Cyl. Oil Gauge Support Group .....	8-6
Fig. 4 - Cummins 6 Cyl. Radiator Group .....	8-8
Fig. 5 - Cummins 6 Cyl. Air Cleaner Group .....	8-10
Fig. 6 - Cummins 6 Cyl. Air Cleaner Seal Group .....	8-12
Fig. 7 - Cummins 6 Cyl. Air Cooler Group .....	8-14
Fig. 8 - Cummins 6 Cyl. Air Cooler, Hydraulic Hose and Fittings Group .....	8-16
Fig. 9 - Cummins 6 Cyl. Hydraulic Hoses and Fittings Group .....	8-18
Fig. 10 - Cummins 6 Cyl. Surge Tank Group .....	8-20
Fig. 11 - Cummins 6 Cyl. Hydraulic Pump Group .....	8-22
Fig. 12 - Cummins 6 Cyl. Muffler Group .....	8-24
Fig. 13 - Cummins 6 Cyl. Battery Group .....	8-26
Fig. 14 - Cummins 6 Cyl. Engine Doors Group .....	8-28
Fig. 15 - Cummins 6 Cyl. Cab Group .....	8-30
Fig. 16 - Cummins 6 Cyl. Instrument Panel Assembly .....	8-32
Fig. 17 - Cummins 6 Cyl. Electrical Group .....	8-34
Fig. 18 - Cummins 6 Cyl. Documentaion Group .....	8-36



# CUMMINS 6 CYLINDER ENGINE BREAKDOWN

Fig. 1 - Cummins 6 Cyl. General Recommended Maintenance Items

Ref.	Tennant Part No.	Machine Serial Number	Description	Qty.
▽	769298	(000000-	) Kit, Maintenance Parts, Emissions	1
▲	769279	(000000-	) Filter, Fuel, Cummins	1
▲	769280	(000000-	) Filter, Hydraulic Cummins	1
▲	769281	(000000-	) Filter, Air Cleaner	1
▲	769294	(000000-	) Belt, Engine, Emissions	1

# CUMMINS 6 CYLINDER ENGINE BREAKDOWN

Fig. 2 - Cummins 6 Cyl. Engine Group

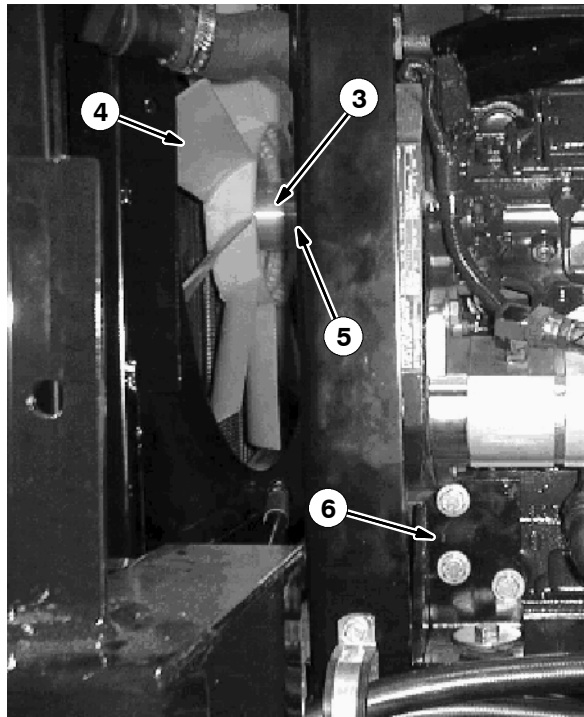
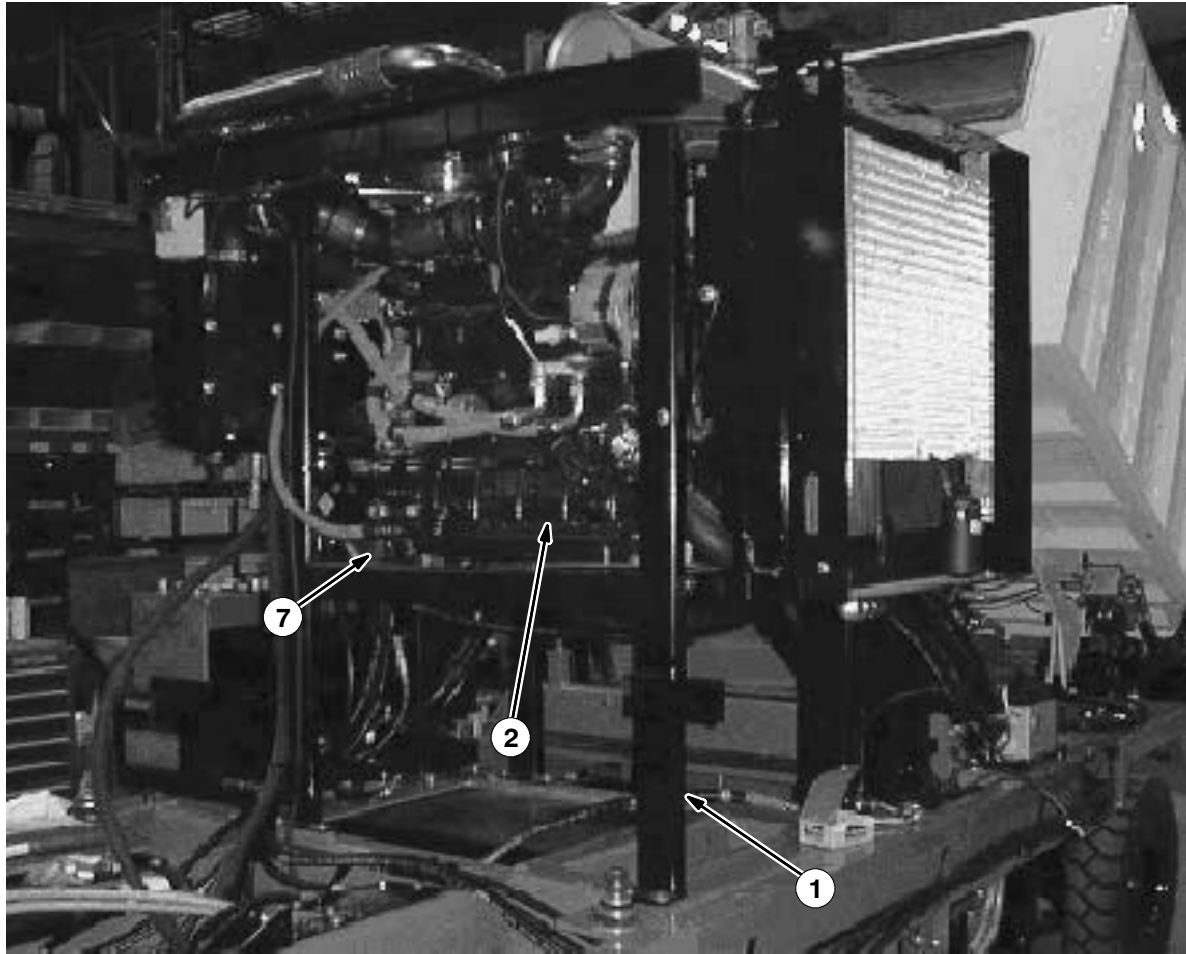

## CUMMINS 6 CYLINDER ENGINE BREAKDOWN

Fig. 2 - Cummins 6 Cyl. Engine Group

Ref.	Tennant Part No.	Machine Serial Number	Description	Qty.
1	769176	(000000-	) Engine Stand	1
2	769175	(000000-	) Engine, Emissions, 6cyl.	1
3	769826	(000000-003214	) Kit, Fan Replacement, 6cyl.	1
3	769824	(003215-	) Spacer, Engine Fan	1
4	769221	(000000-003214	) Kit, Fan Replacement, 6cyl.	1
4	769221	(003215-	) Fan, Engine	1
5	769294	(000000-	) Belt, Engine, Emissions	1
6	769112	(000000-	) Bracket Wldt, Engine, Front Lh	1
7	769114	(000000-	) Bracket Wldt, Engine, Rear Rh	1
	769118	(000000-	) Bracket Wldt, Engine, Rear Lh	1
	764015	(000000-	) Isolator	4
8	769331	(000000-	) Flywheel and Ring Gear (not Shown)	1
9	769332	(000000-	) Ring Gear (not Shown)	1
10	762417	(000000-	) Hose	1
11	769204	(000000-	) Fitting 90	1
12	769352	(000000-	) Plug	1

**Fig. 3 -Cummins 6 Cyl. Oil Gauge Support Group**

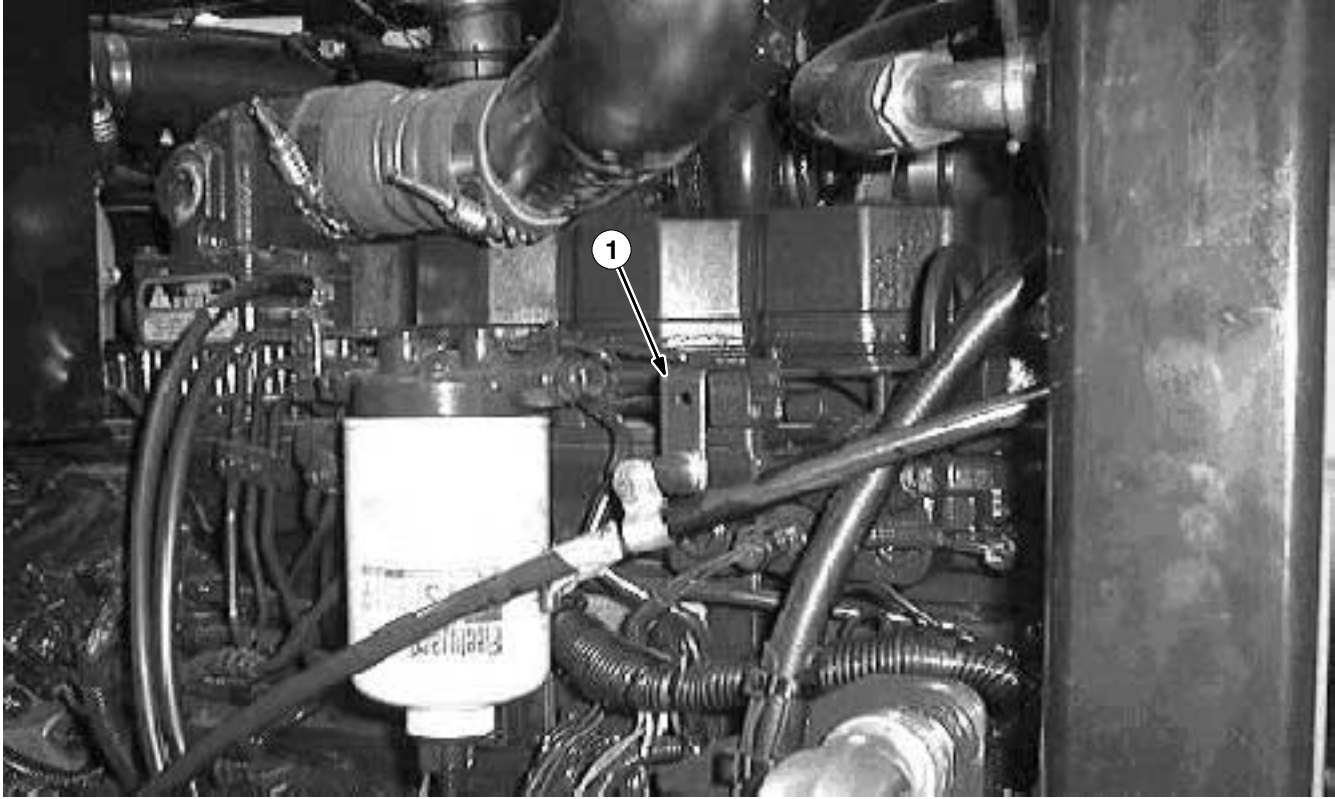



# CUMMINS 6 CYLINDER ENGINE BREAKDOWN

Fig. 3 - Cummins 6 Cyl. Oil Gauge Support Group

Ref.	Tennant Part No.	Machine Serial Number	Description	Qty.
1	769303	(000000-	) Bracket, Dipstick	1

# CUMMINS 6 CYLINDER ENGINE BREAKDOWN

Fig. 4 - Cummins 6 Cyl. Radiator Group

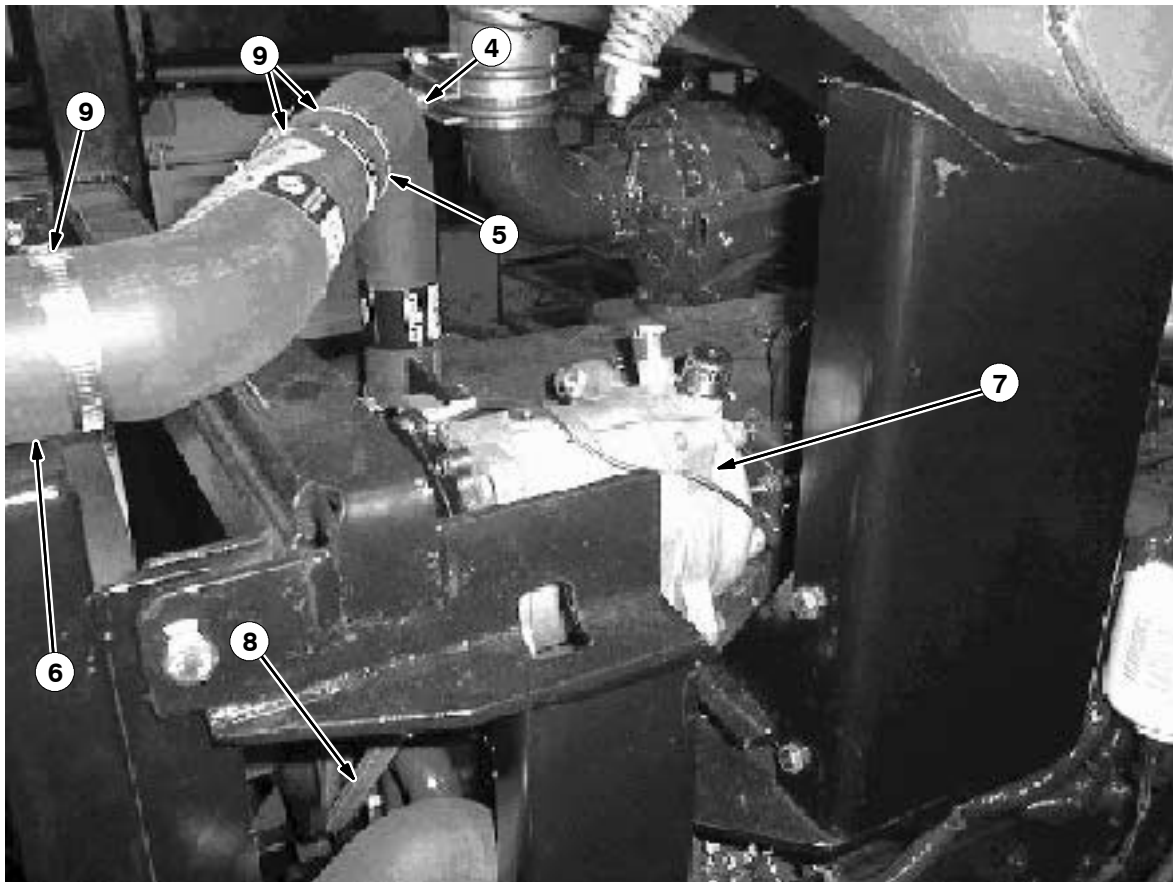
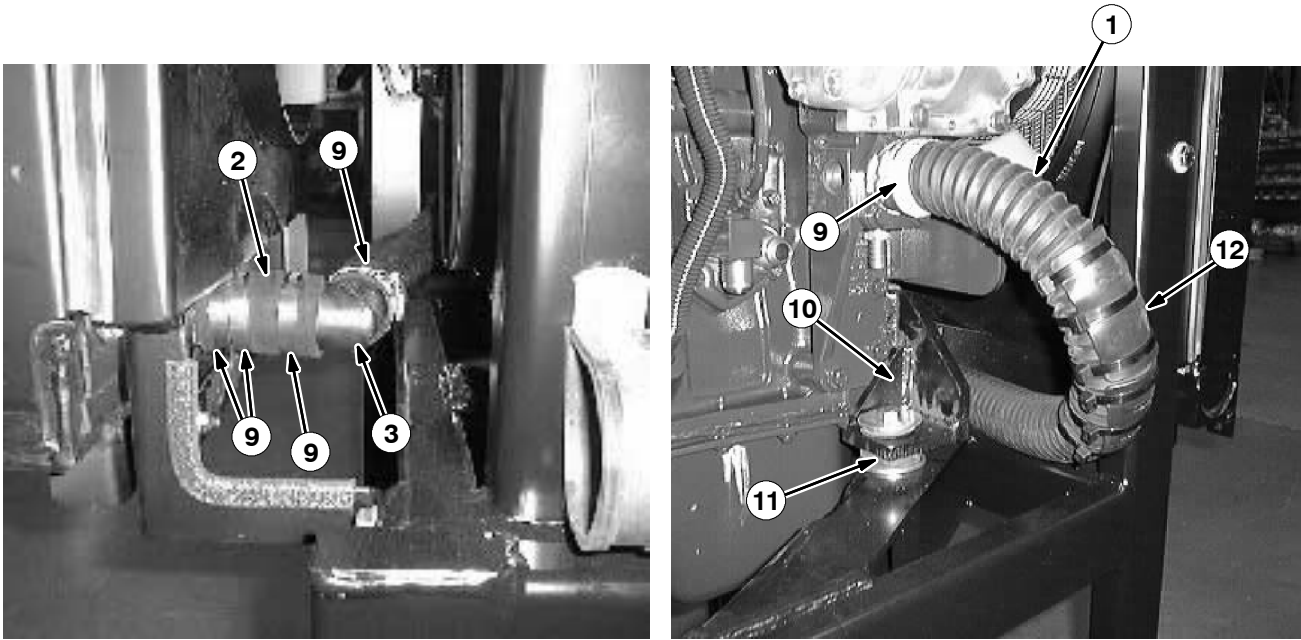

## CUMMINS 6 CYLINDER ENGINE BREAKDOWN

**Fig. 4 - Cummins 6 Cyl. Radiator Group**

Ref.	Tennant Part No.	Machine Serial Number	Description	Qty.
1	769748	(000000-	) Hose, Radiator	1
2	769746	(000000-	) Hose, Radiator	1
3	769745	(000000-	) Tube, Radiator, Lower	1
4	769164	(000000-	) Hose, Engine, Upper	1
5	769160	(000000-	) Tube, Water, Upper	1
6	769163	(000000-	) Hose, Radiator Upper	1
▽	Standard	(000000-	) Radiator W/Hyd. Cooler/Shroud	1
▲	769217	(000000-	) Radiator	1
▲	Standard	(000000-	) Hydraulic Cooler	1
7	77674	(000000-	) Compressor, Air Cond. 6cyl. Cummins	1
8	769258	(000000-	) Belt, A/C	1
9	17188	(000000-	) Clamp, Wormdrive, 1.62- 3.50d	8
10	769109	(000000-	) Bracket Wldt, Engine Front Rh	1
11	764015	(000000-	) Isolator	2
12	762178	(000000-	) Guard, Hose, Rubber 3"	1

# CUMMINS 6 CYLINDER ENGINE BREAKDOWN

Fig. 5 - Cummins 6 Cyl. Air Cleaner Group

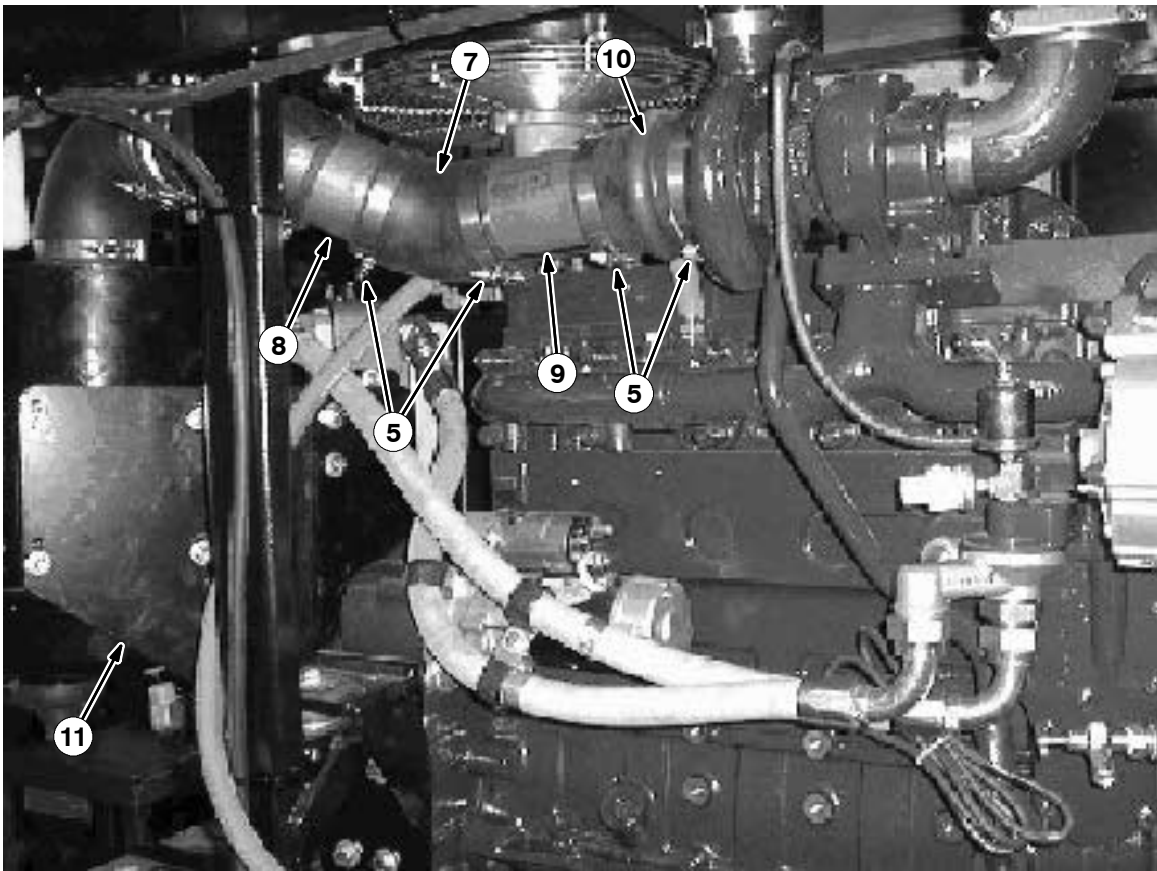
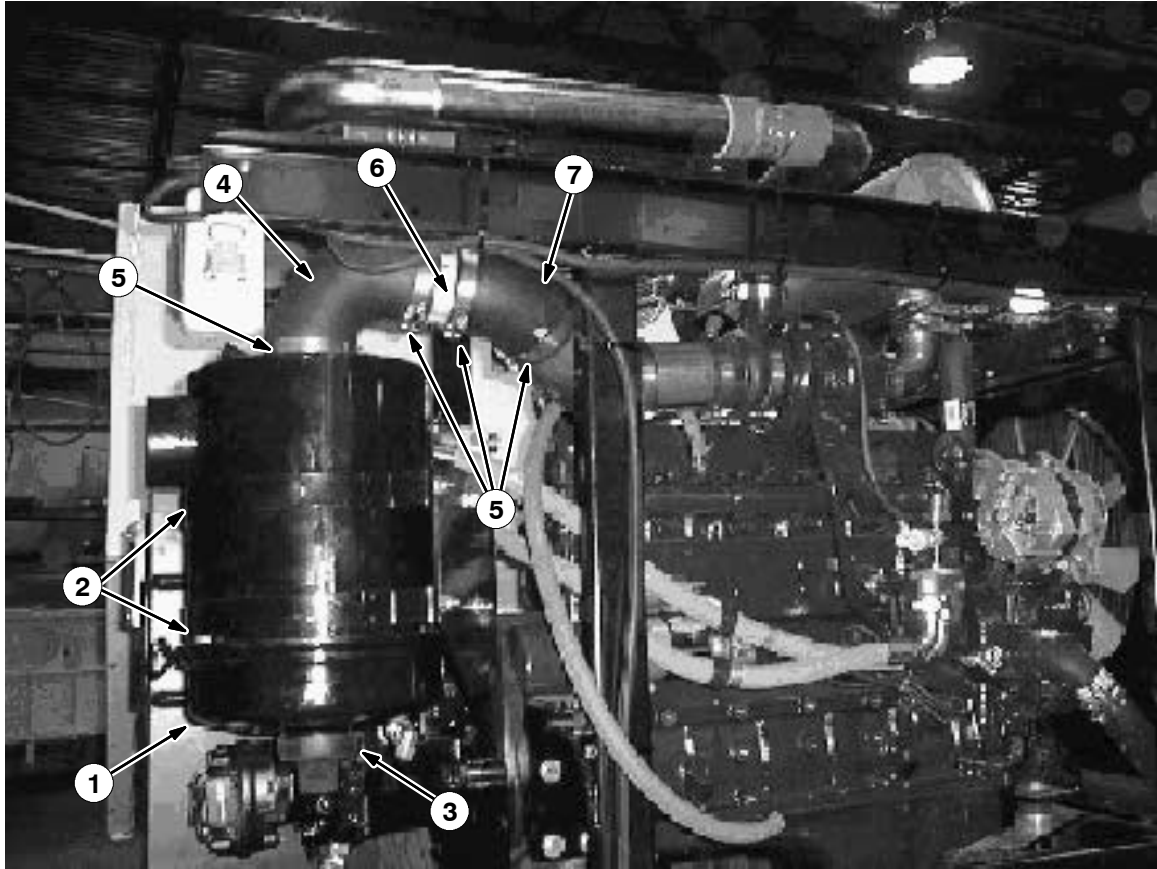

## CUMMINS 6 CYLINDER ENGINE BREAKDOWN

Fig. 5 - Cummins 6 Cyl. Air Cleaner Group

Ref.	Tennant Part No.	Machine Serial Number	Description	Qty.
1	769194	(000000-	) Air Cleaner, Donaldson	1
2	769196	(000000-	) Strap, Mount, Air Cleaner 12" Dia	2
3	769254	(000000-	) Cup, Air Cleaner, Emissions	1
4	769207	(000000-	) Elbow, Rubber 4" Dia x 90 Deg.	1
5	766006	(000000-	) Clamp, 4' Hose	8
6	769193	(000000-	) Tube, Intake, Short	2
7	766009	(000000-	) Elbow, 4" X 45 Degree	2
8	769241	(000000-	) Tube, Air Intake	1
9	769192	(000000-	) Tube, Intake, Long	1
10	764292	(000000-	) Adaptor, Rubber, Air Cleaner	1
11	769190	(000000-	) Plate, Mount, Air Cleaner	1

**Fig. 6 - Cummins 6 Cyl. Air Cleaner Seal Group**



# CUMMINS 6 CYLINDER ENGINE BREAKDOWN

Fig. 6 - Cummins 6 Cyl. Air Cleaner Seal Group

Ref.	Tennant Part No.	Machine Serial Number	Description	Qty.
1	769233	(000000-	) Seal, Air Cleaner	1
2	765806	(000000-	) Clamp, Air Cleaner	1

# CUMMINS 6 CYLINDER ENGINE BREAKDOWN

Fig. 7 - Cummins 6 Cyl. Air Cooler Group

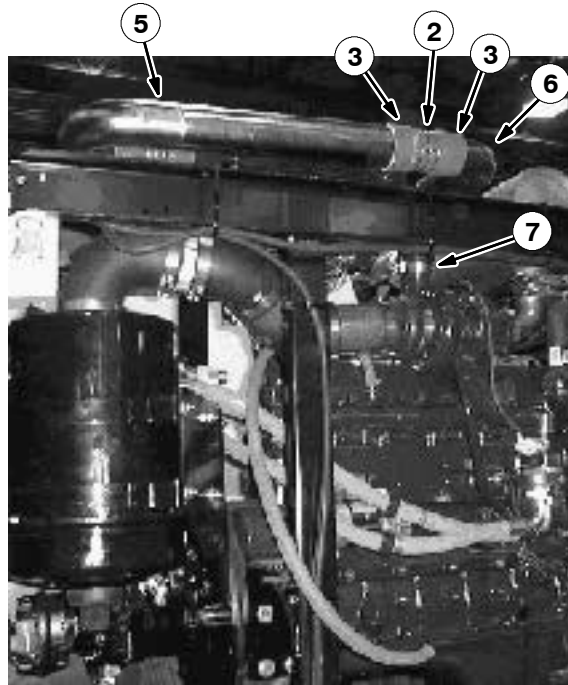
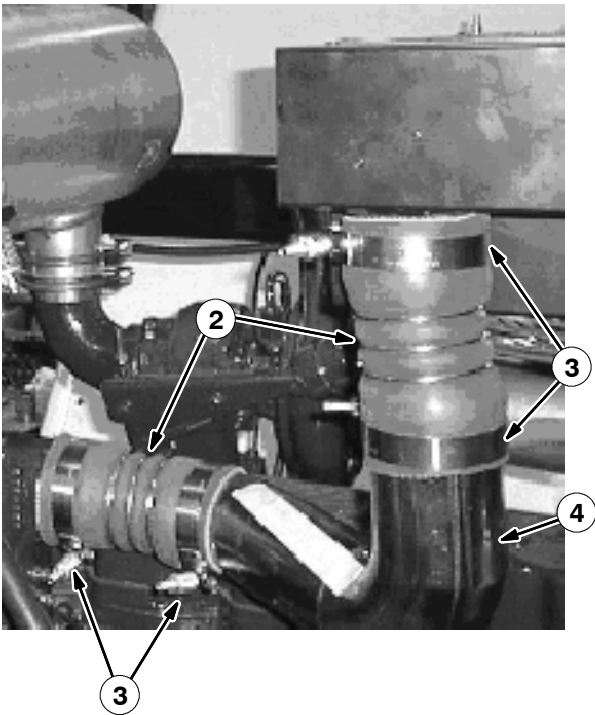
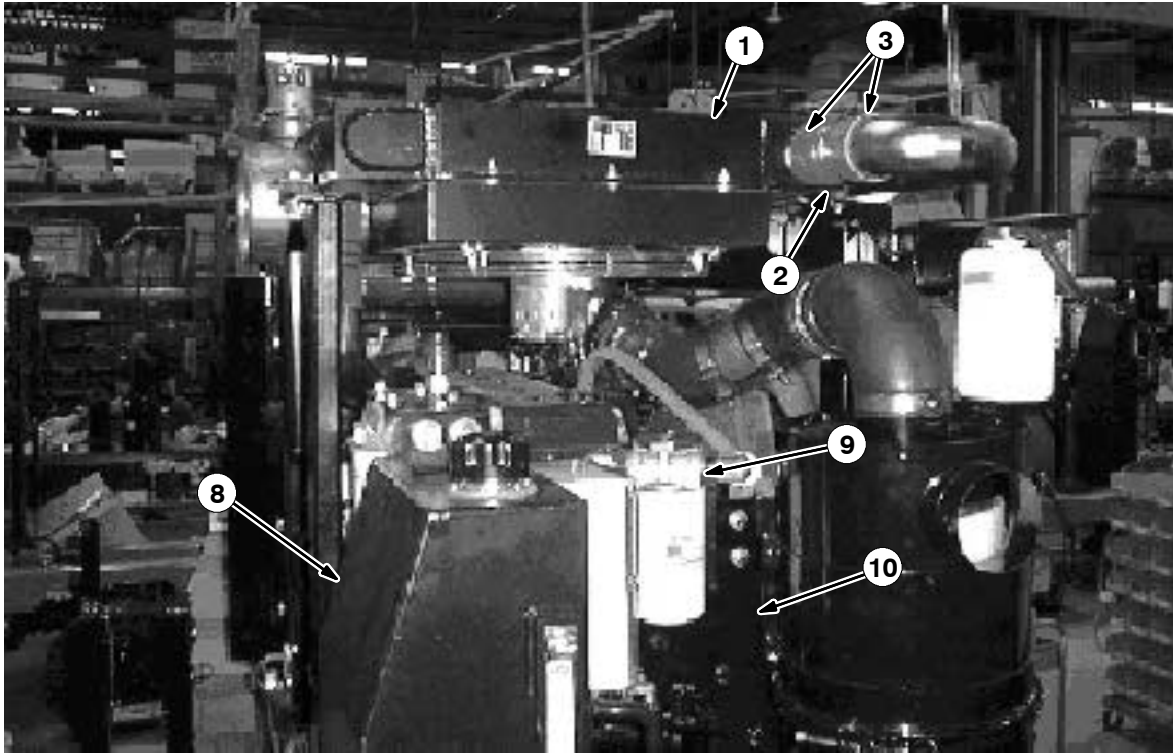



# CUMMINS 6 CYLINDER ENGINE BREAKDOWN

Fig. 7 - Cummins 6 Cyl. Air Cooler Group

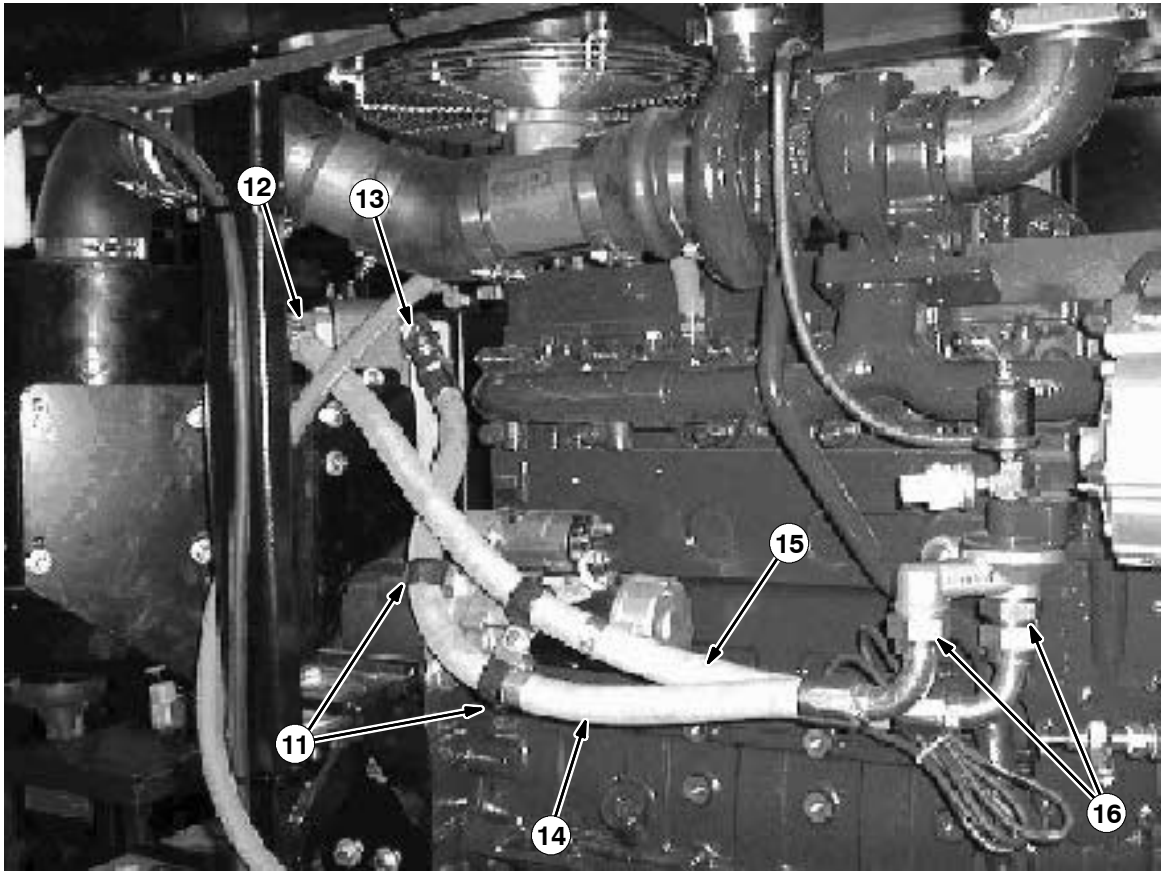

Ref.	Tennant Part No.	Machine Serial Number	Description	Qty.
▽	1	769195	(000000- ) Cooler, Assembly, Charge Air	1
▲▽		769333	(000000- ) Motor, Hyd	1
▲▲		769308	(000000- ) Seal Kit	1
2	769208	(000000- )	Hose, Turbo 3" Dia	4
3	769197	(000000- )	Clamp, Spring Turbo	8
4	769198	(000000- )	Tube, Engine Inlet	1
5	769215	(000000- )	Tube, Turbo Long	1
6	769214	(000000- )	Tube, Turbo Short	1
7	769216	(000000- )	Clamp, Vee, Turbo	1
8	769278	(000000- )	Tank Modification, Hyd. Emissions	1
9	769249	(000000- )	Filter, Hyd. W/Bracket	1
10	769253	(000000- )	Bracket, Filter Remote	1
11	69234	(000000- )	Clamp	3
12	769334	(000000- )	Fitting, Hyd	1
13	769335	(000000- )	Fitting, Hyd	1
14	769336	(000000- )	Hose, Hyd	1
15	769337	(000000- )	Hose, Hyd	1
16	769338	(000000- )	Fitting, Hyd	2

# CUMMINS 6 CYLINDER ENGINE BREAKDOWN

Fig. 8 - Cummins 6 Cyl. Air Cooler, Hydraulic Hose and Fittings Group

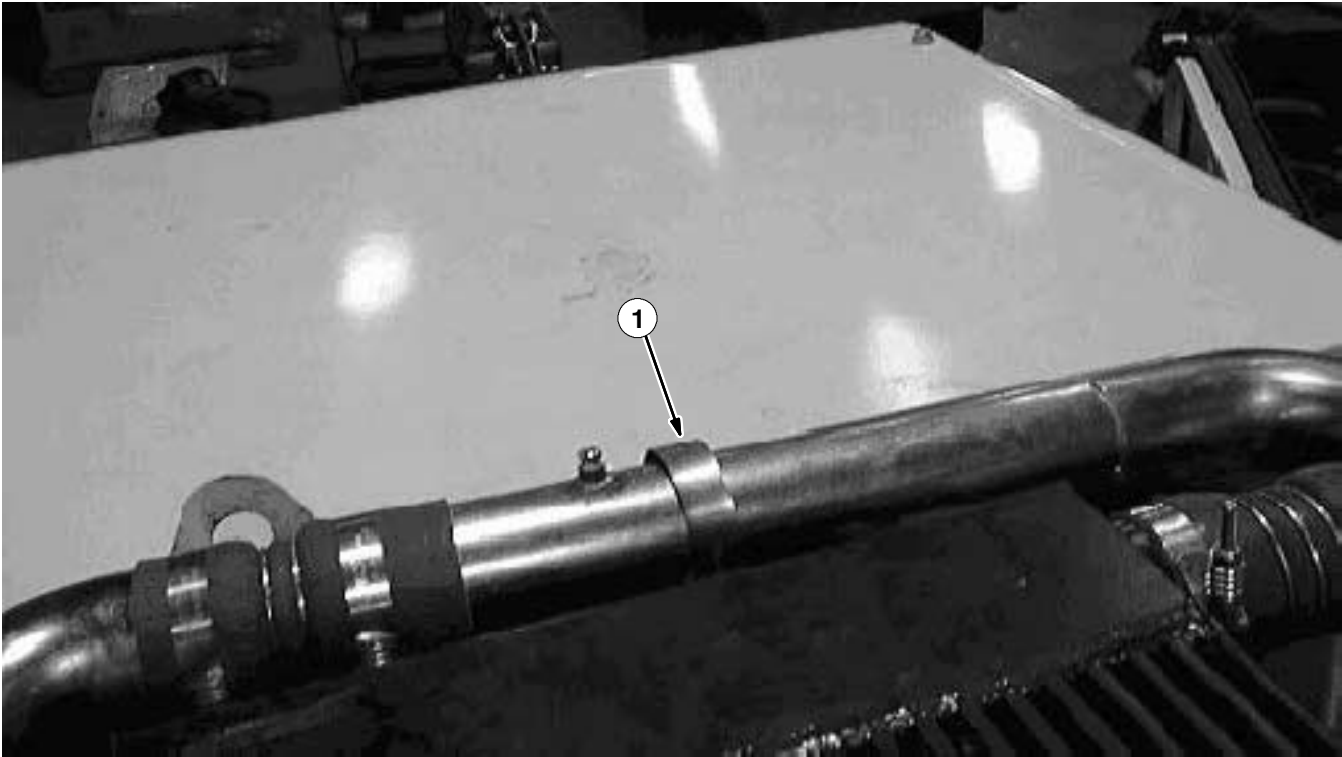

## CUMMINS 6 CYLINDER ENGINE BREAKDOWN

Fig. 8 - Cummins 6 Cyl. Air Cooler, Hydraulic Hose and Fittings Group

Ref.	Tennant Part No.	Machine Serial Number	Description	Qty.
1	34312	(000000-	) Clamp	1
2	762433	(000000-	) Fitting	1
3	769314	(000000-	) Hose	1
4	769339	(000000-	) Hose	1
5	767406	(000000-	) Fitting	2
6	769341	(000000-	) Hose	1
7	769342	(000000-	) Fitting, Motor Case Drain	1
8	766343	(000000-	) Fitting	1
9	769348	(000000-	) Hose, Case Drain	1
10	762496	(000000-	) Adaptor (Not Shown Case Drain into Tank)	1
11	762436	(000000-	) Fitting (Not Shown into Adaptor)	1

# CUMMINS 6 CYLINDER ENGINE BREAKDOWN

Fig. 9 - Cummins 6 Cyl. Hydraulic Hoses and Fittings Group

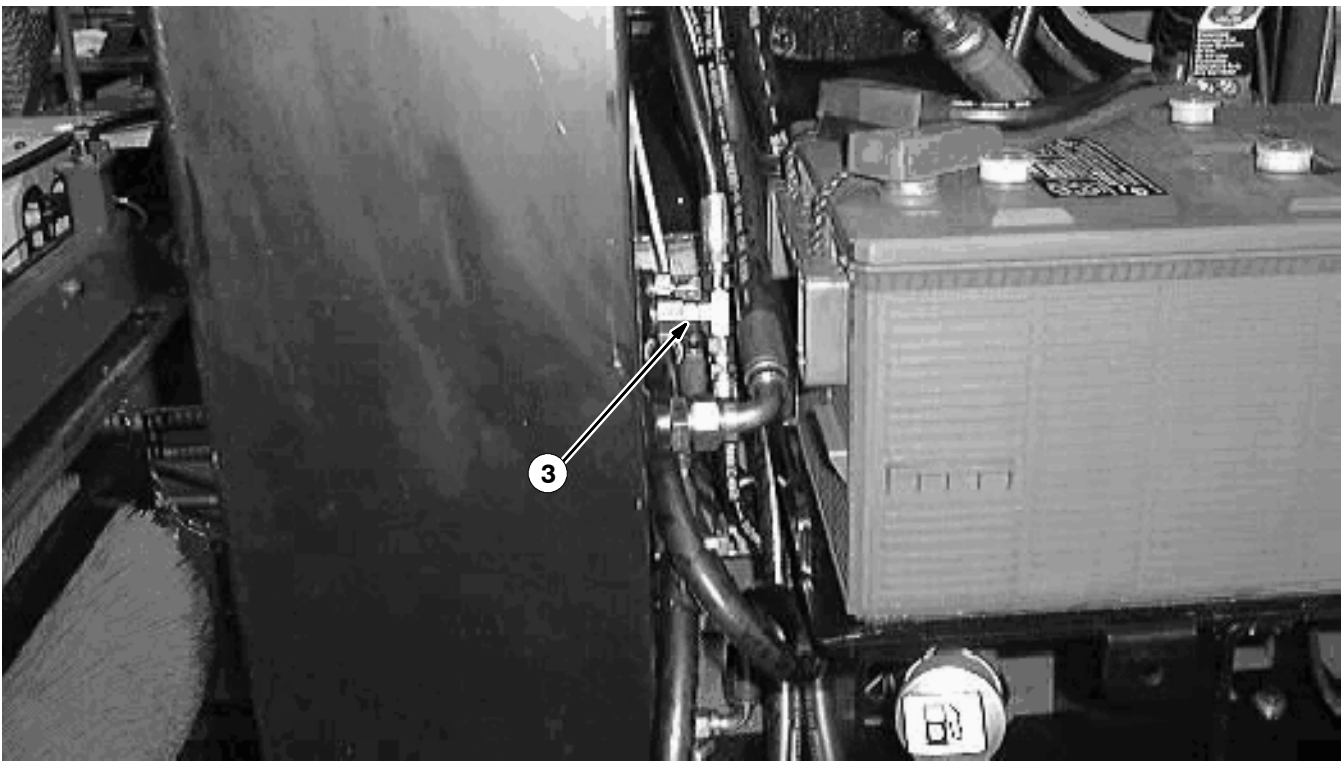
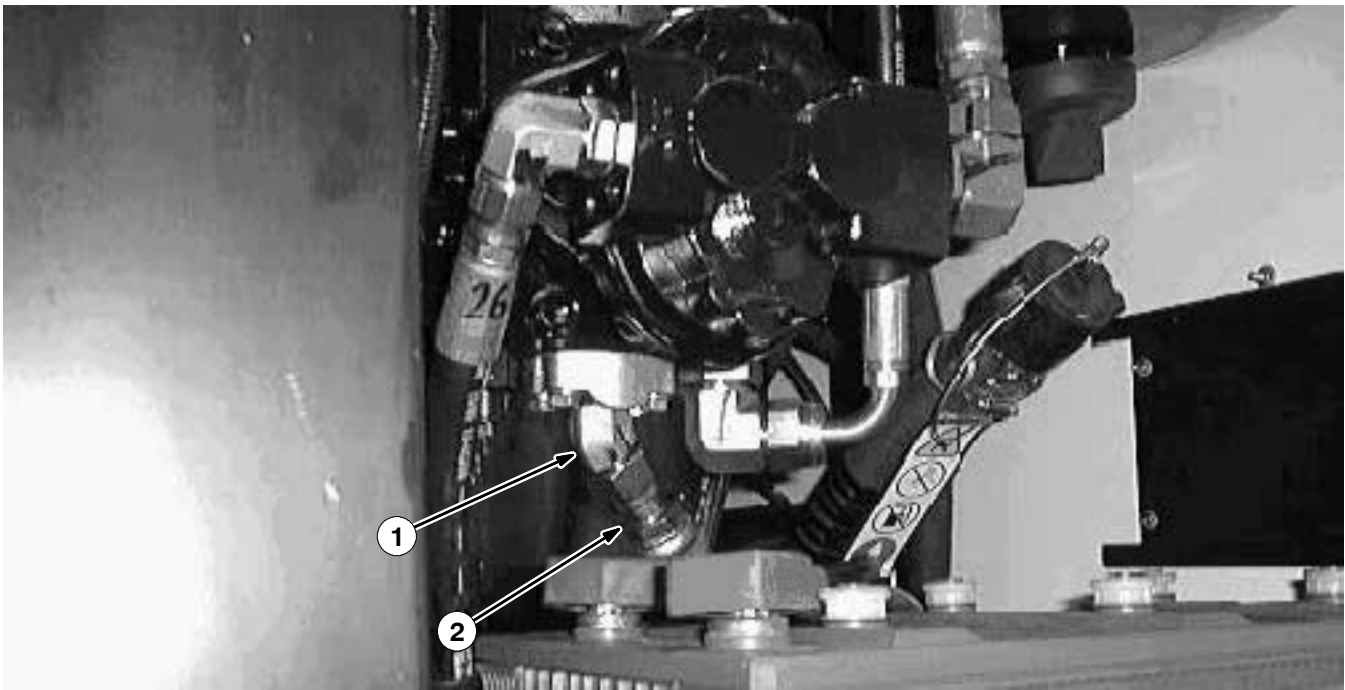

# CUMMINS 6 CYLINDER ENGINE BREAKDOWN

Fig. 9 - Cummins 6 Cyl. Hydraulic Hoses and Fittings Group

Ref.	Tennant Part No.	Machine Serial Number	Description	Qty.
1	769345	(000000-	) Fitting, Hyd 45 Flange to Face Seal	1
2	769346	(000000-	) Hose, Hyd	1
3	769347	(000000-	) Fitting, Hyd, Tee	1

# CUMMINS 6 CYLINDER ENGINE BREAKDOWN

Fig. 10 - Cummins 6 Cyl. Surge Tank Group

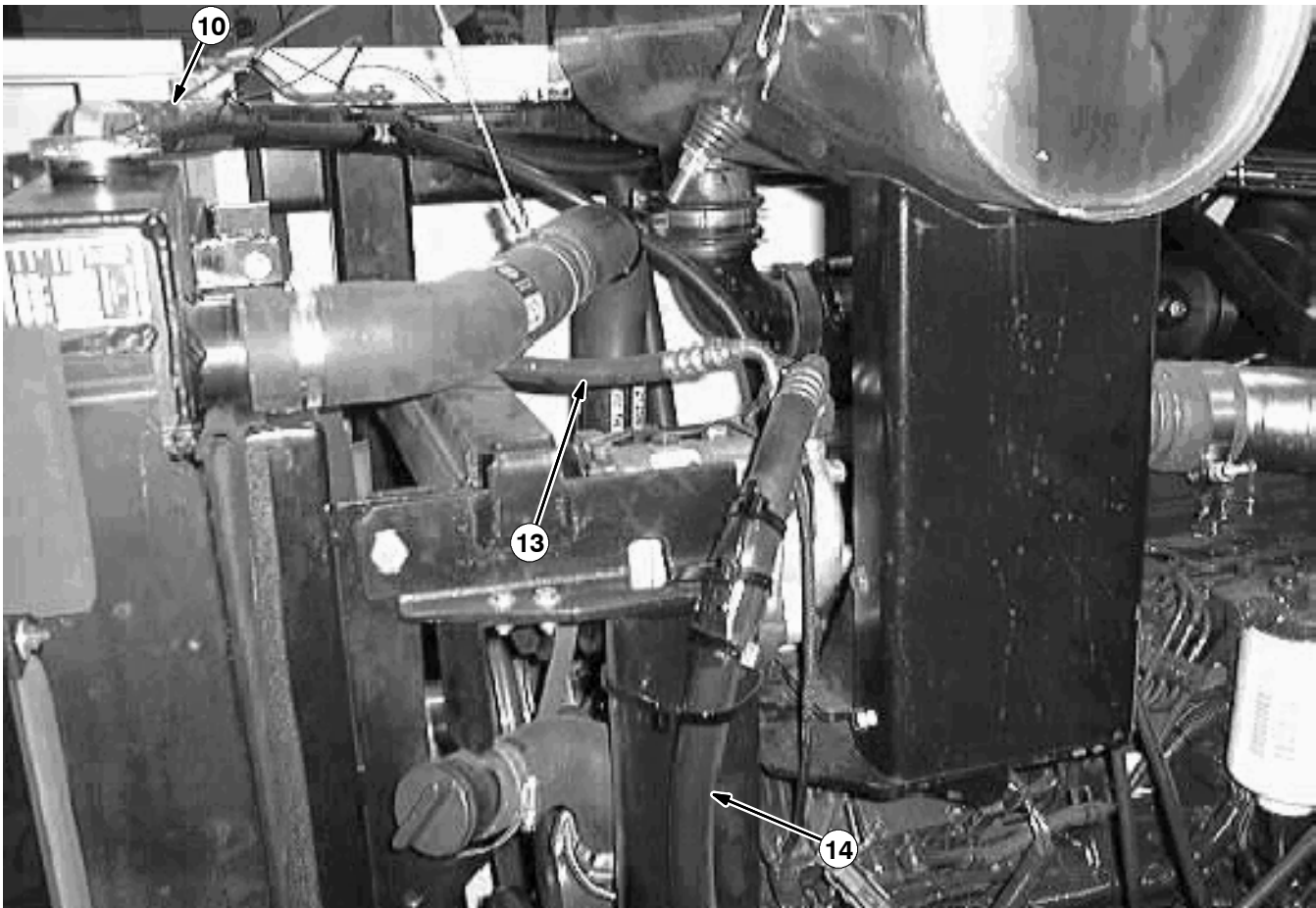
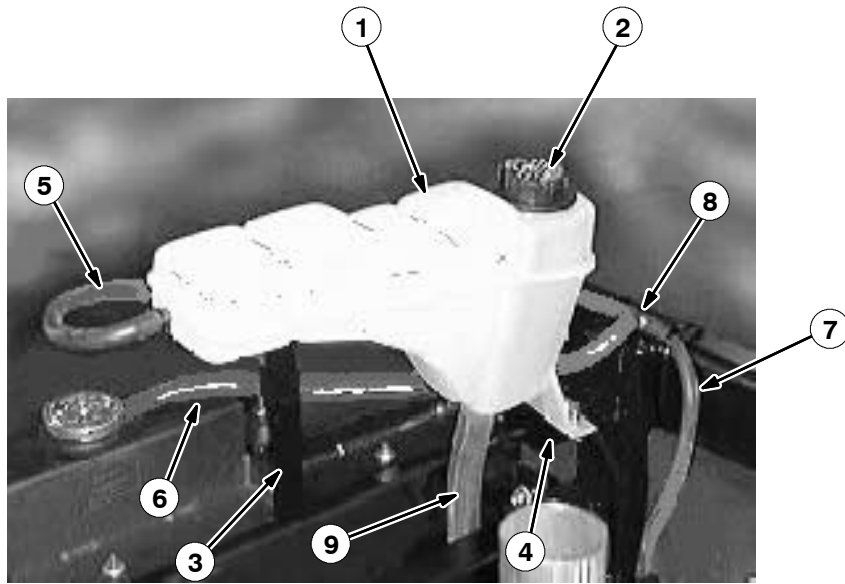

## CUMMINS 6 CYLINDER ENGINE BREAKDOWN

**Fig. 10 - Cummins 6 Cyl. Surge Tank Group**

Ref.	Tennant Part No.	Machine Serial Number	Description	Qty.
1	769464	(000000-	) Tank, Surge Emissions	1
2	769329	(000000-	) Cap	1
3	769804	(000000-	) Bracket	1
4	769805	(000000-	) Bracket	1
5	769806	(000000-	) Hose, Tank to Barbed Fitting	1
6	769808	(000000-	) Hose, Radiator to Barbed Fitting	1
7	769807	(000000-	) Hose, Barbed Fitting to Engine	1
8	769763	(000000-	) Barbed Fitting	1
9	769792	(000000-	) Hose	1
10	769349	(000000-	) Hose	1
11	769350	(000000-	) Valve, Bleeder, Cummins (Not Shown)	1
12	769351	(000000-	) Fitting, Hyd, Cummins (Not Shown)	1
13	769354	(000000-	) Hose, Compressor to Condenser	1
14	769353	(000000-	) Hose, Evaporator to Compressor	1
15	769355	(000000-	) Hose, Dryer to Evaporator (Not Shown)	1

# CUMMINS 6 CYLINDER ENGINE BREAKDOWN

Fig. 11 - Cummins 6 Cyl. Hydraulic Pump Group

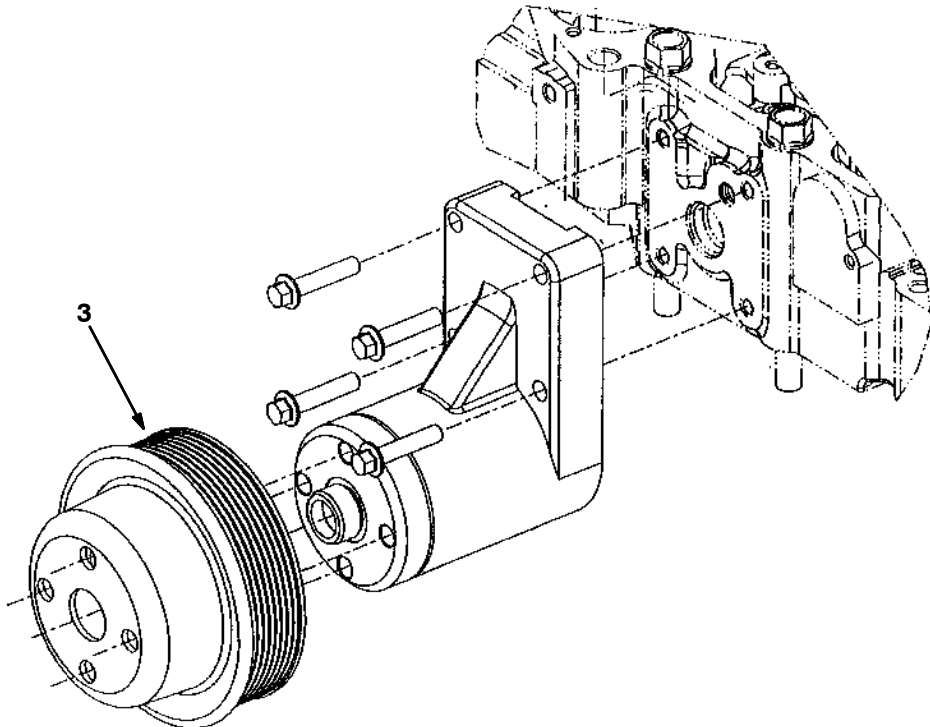
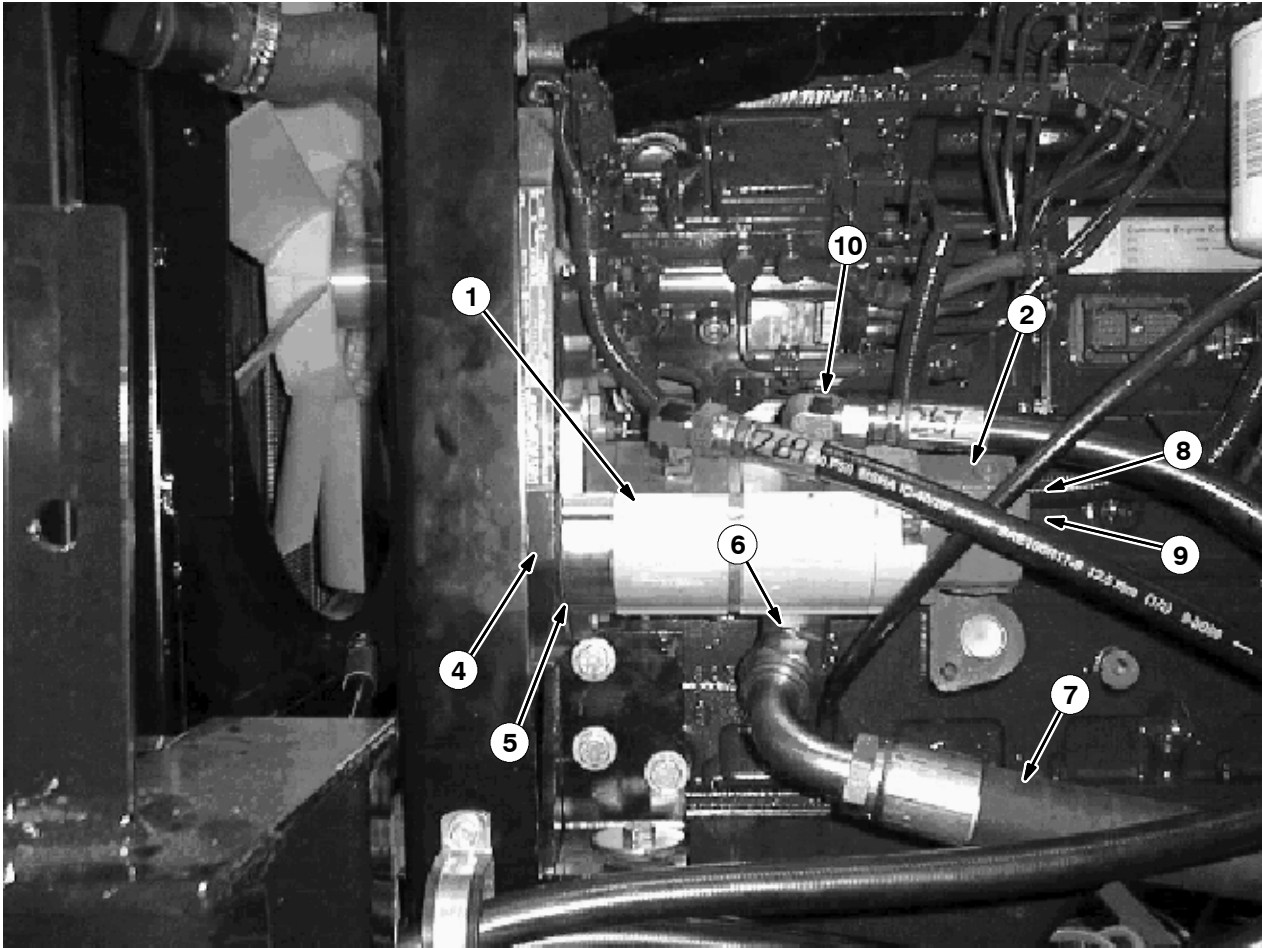



## CUMMINS 6 CYLINDER ENGINE BREAKDOWN

Fig. 11 - Cummins 6 Cyl. Hydraulic Pump Group

Ref.	Tennant Part No.	Machine Serial Number	Description	Qty.
1	769185	(000000-	) Pump, Hydraulic Barnes	1
2	769186	(000000-	) Pump, Barnes, GC Third Section	1
3	769328	(000000-	) Pulley, Fan, Cummins	1
4	769457	(000000-	) Gear, Pump	1
5	769459	(000000-	) Gasket Pump Kit	1
6	762484	(000000-	) Fitting, Hyd	1
7	769238	(000000-	) Hose	1
8	762439	(000000-	) Fitting, Hyd	1
9	762438	(000000-	) Fitting, Hyd	1
10	762464	(000000-	) Fitting, Hyd	1

Fig. 12 - Cummins 6 Cyl. Muffler Group

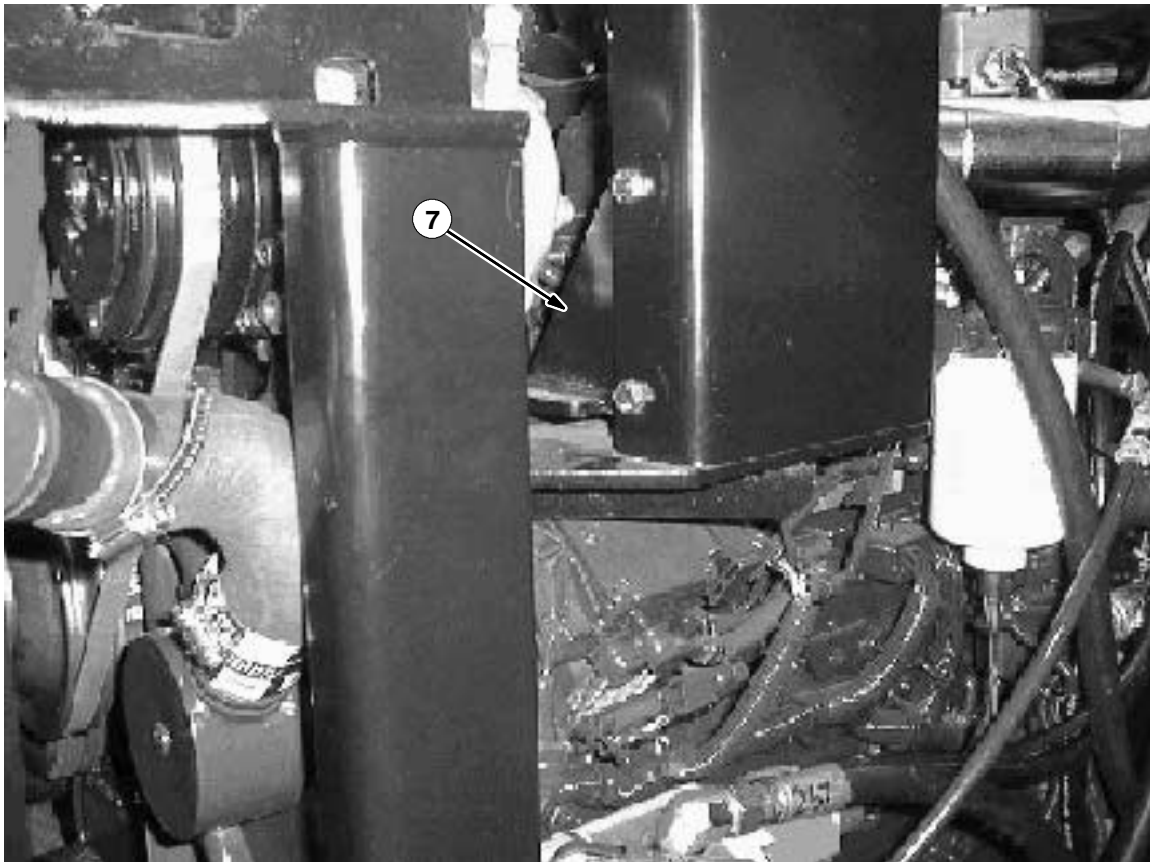
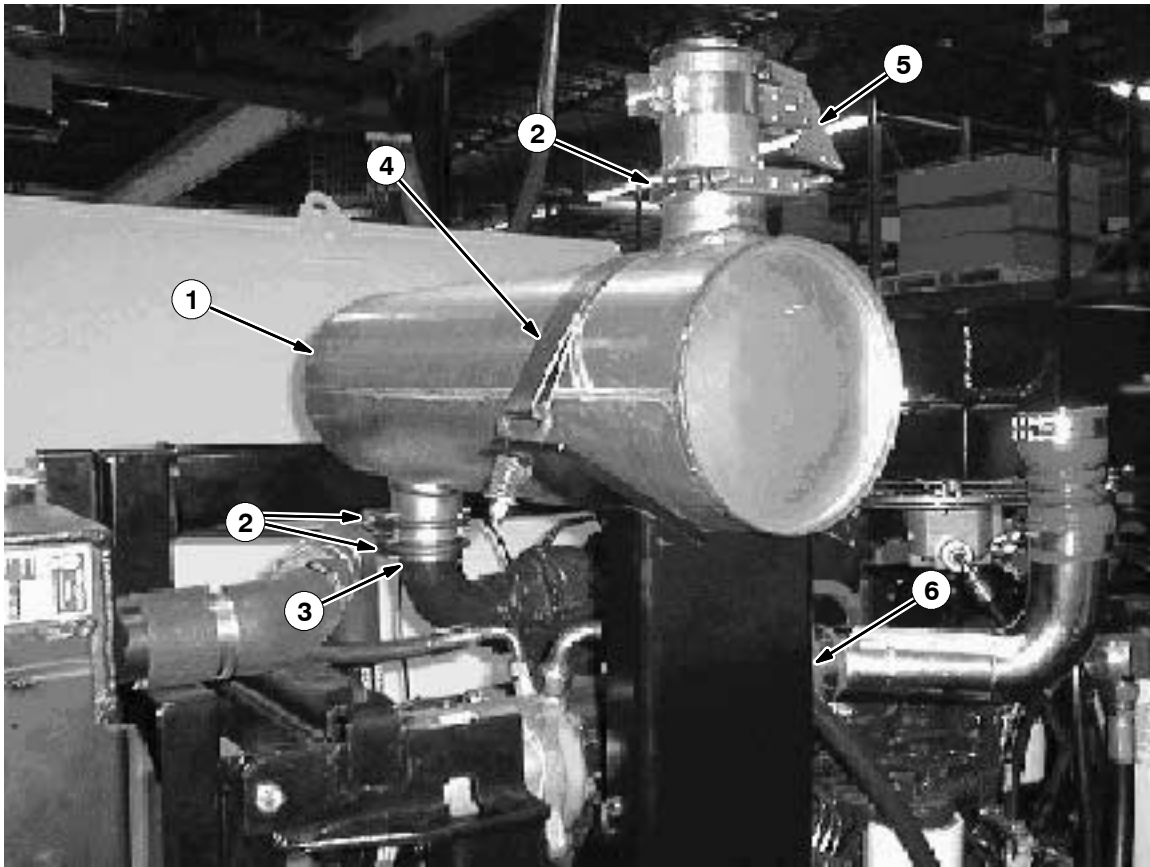

# CUMMINS 6 CYLINDER ENGINE BREAKDOWN

Fig. 12 - Cummins 6 Cyl. Muffler Group

Ref.	Tennant Part No.	Machine Serial Number	Description	Qty.
1	769182	(000000-	) Muffler, Donaldson	1
2	769165	(000000-	) Clamp, Muffler, 3" Dia	3
3	769228	(000000-	) Tube, Adaptor, Muffler	1
4	769246	(000000-	) Strap, Muffler	2
5	769184	(000000-	) Cap, Rain, Donaldson	1
6	769225	(000000-	) Muffler Mount Wldt	1
7	769224	(000000-	) Strap Wldt, Muffler	1

**Fig. 13 - Cummins 6 Cyl. Battery Group**

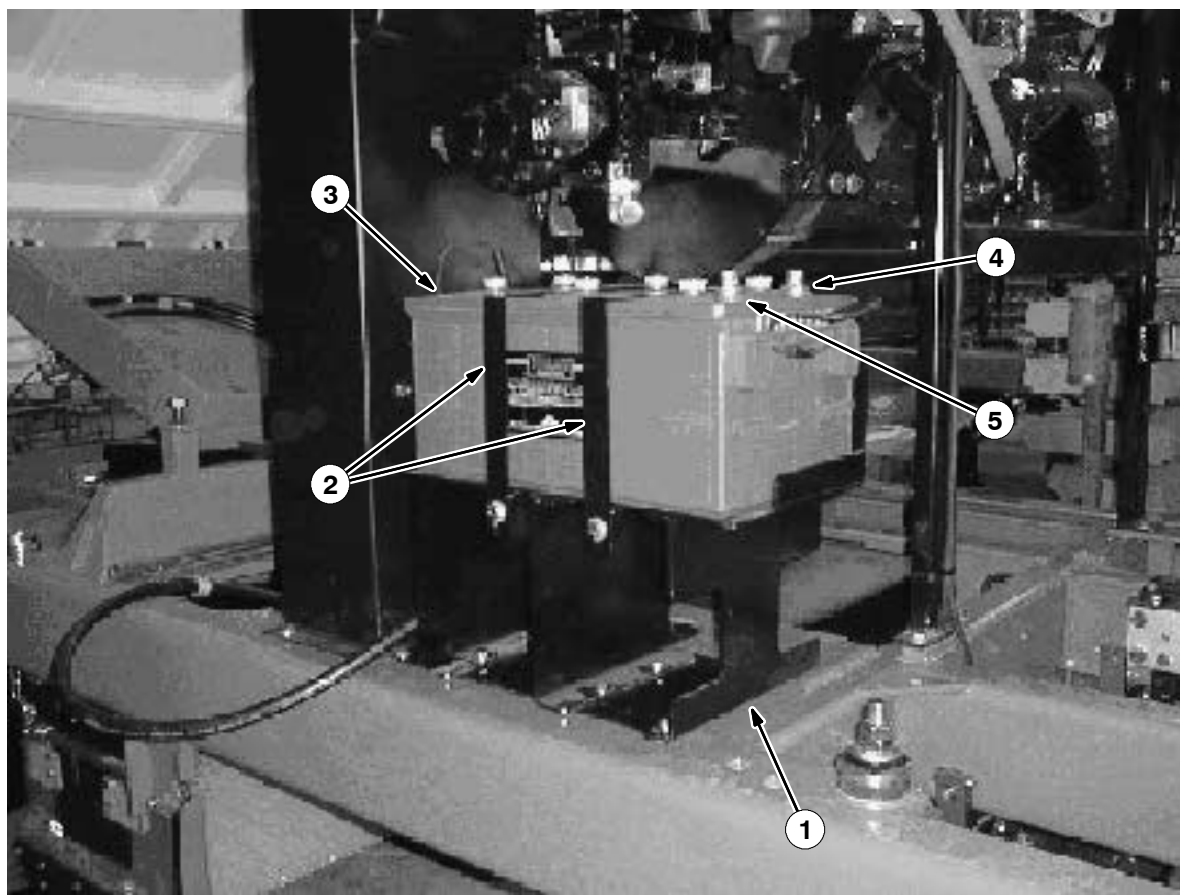

# CUMMINS 6 CYLINDER ENGINE BREAKDOWN

Fig. 13 - Cummins 6 Cyl. Battery Group

Ref.	Tennant Part No.	Machine Serial Number	Description	Qty.
1	766030	(000000-	) Support Wldt, Battery	1
2	766029	(000000-	) Bracket, Battery Retainer	2
3	769220	(000000-	) Battery, Trojan	1
4	310593	(000000-	) Cable, Battery, Pos 0ga 51.0l	1
5	310594	(000000-	) Cable, Battery, Neg 0ga 37.0l	1

# CUMMINS 6 CYLINDER ENGINE BREAKDOWN

Fig. 14 - Cummins 6 Cyl. Engine Doors Group

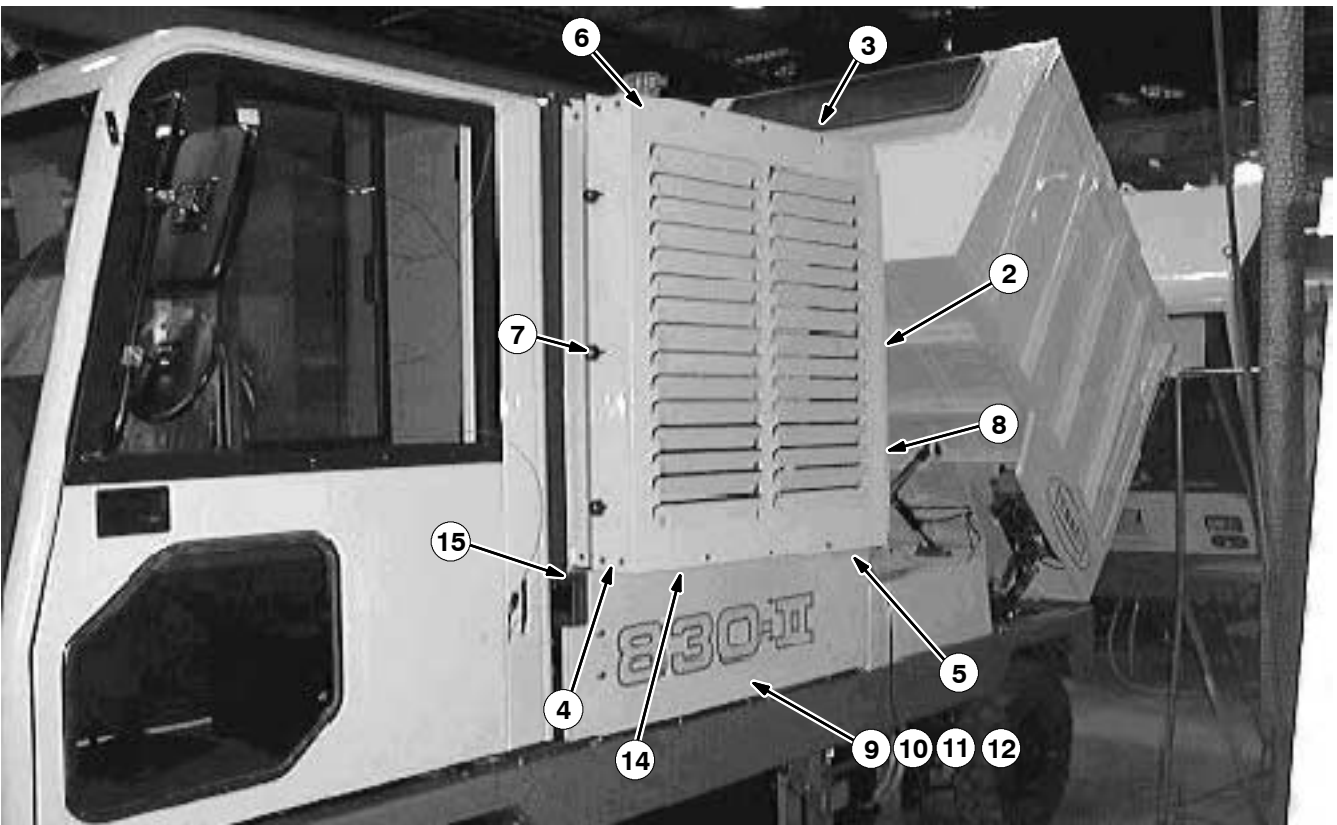
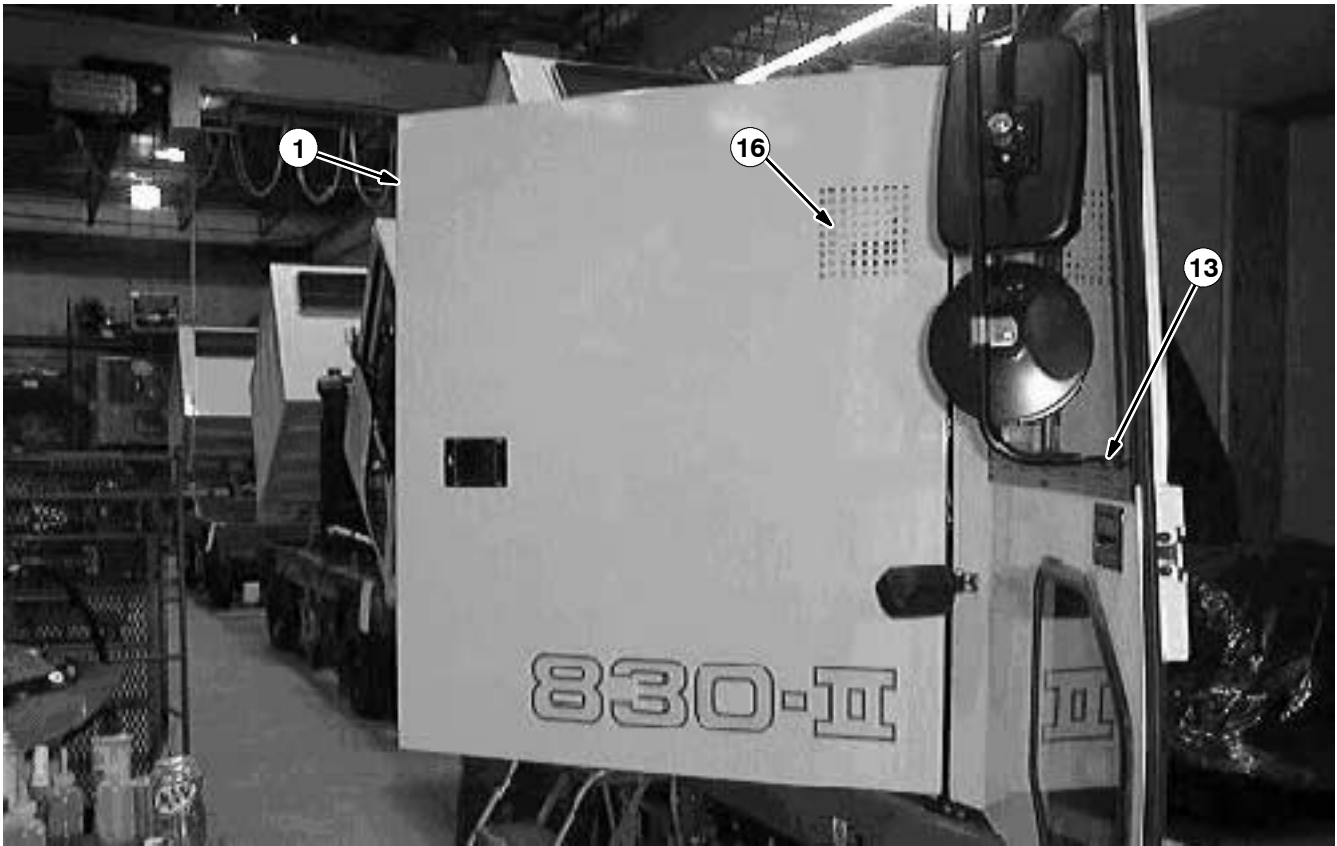

## CUMMINS 6 CYLINDER ENGINE BREAKDOWN

Fig. 14 - Cummins 6 Cyl. Engine Doors Group

Ref.	Tennant Part No.	Machine Serial Number	Description	Qty.
1	766520	(000000-	) Door Wldt, Engine Rh (Less Handle)	1
2	766530	(000000-	) Door Wldt, Engine Lh (Less Handle)	1
3	766532	(000000-	) Bracket, Cover, Top, Lh	1
4	766533	(000000-	) Bracket, Brace	2
5	766534	(000000-	) Bracket, Cover, Bottom, Lh	1
6	766543	(000000-	) Bracket, Stiffener, Top	1
7	364614	(000000-	) Bumper, Neoprene	3
8	766544	(000000-	) Bracket, Door Stop	1
9	766540	(000000-	) Cover, Lower, Lh	1
10	766541	(000000-	) Bracket, Cover Mtg	2
11	766542	(000000-	) Bracket, Cover Mtg	1
12	769232	(000000-	) Angle Cover Mtg, Lh	2
13	769371	(000000-	) Plate, Mounting, Mirror	2
14	766535	(000000-	) Seal Rubber, Engine Door	1
15	766524	(000000-	) Shim Door	3
16	766523	(000000-	) Cover, Vent	1

# CUMMINS 6 CYLINDER ENGINE BREAKDOWN

Fig. 15 - Cummins 6 Cyl. Cab Group



Water in Fuel  
See Page 1-69

Stop Engine  
See Page 1-54

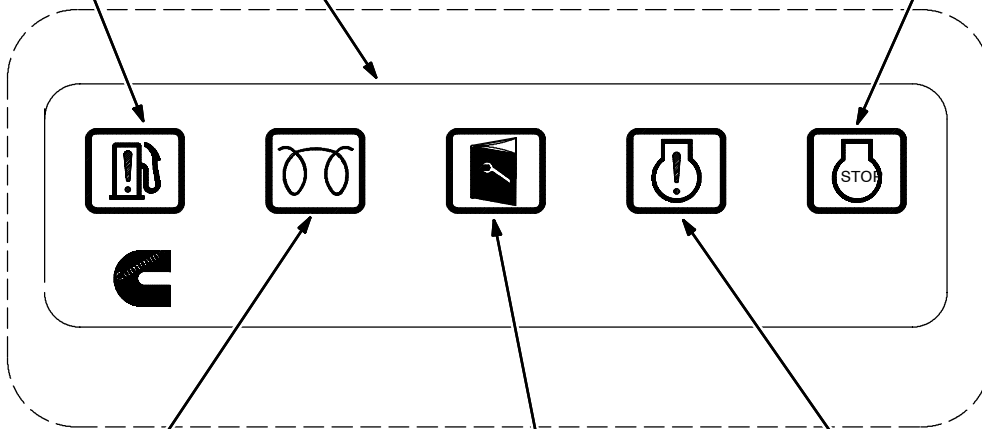

Wait to start  
See Page 1-69

Maintenance  
See Page 1-54  
Thru 1-68

Diagnostics Warning  
See Page 1-54



# CUMMINS 6 CYLINDER ENGINE BREAKDOWN

Fig. 15 - Cummins 6 Cyl. Cab Group

Ref.	Tennant Part No.	Machine Serial Number	Description	Qty.
1	769255	(000000-	) Console, Steering, Emissions	1
	769256	(000000-	) Label, Console, Emissions	1
2	769283	(000000-	) Lamp, Red, Sorenson	1
3	769284	(000000-	) Lamp, Amber, Sorenson	2
4	769286	(000000-	) Lamp, Green, Sorenson	1
5	769285	(000000-	) Lamp, Blue, Sorenson	1
6	769291	(000000-	) Label, Warning Lamp	1
7	769250	(000000-	) Throttle Control Lever	1

# CUMMINS 6 CYLINDER ENGINE BREAKDOWN

Fig. 16 - Cummins 6 Cyl. Instrument Panel Assembly

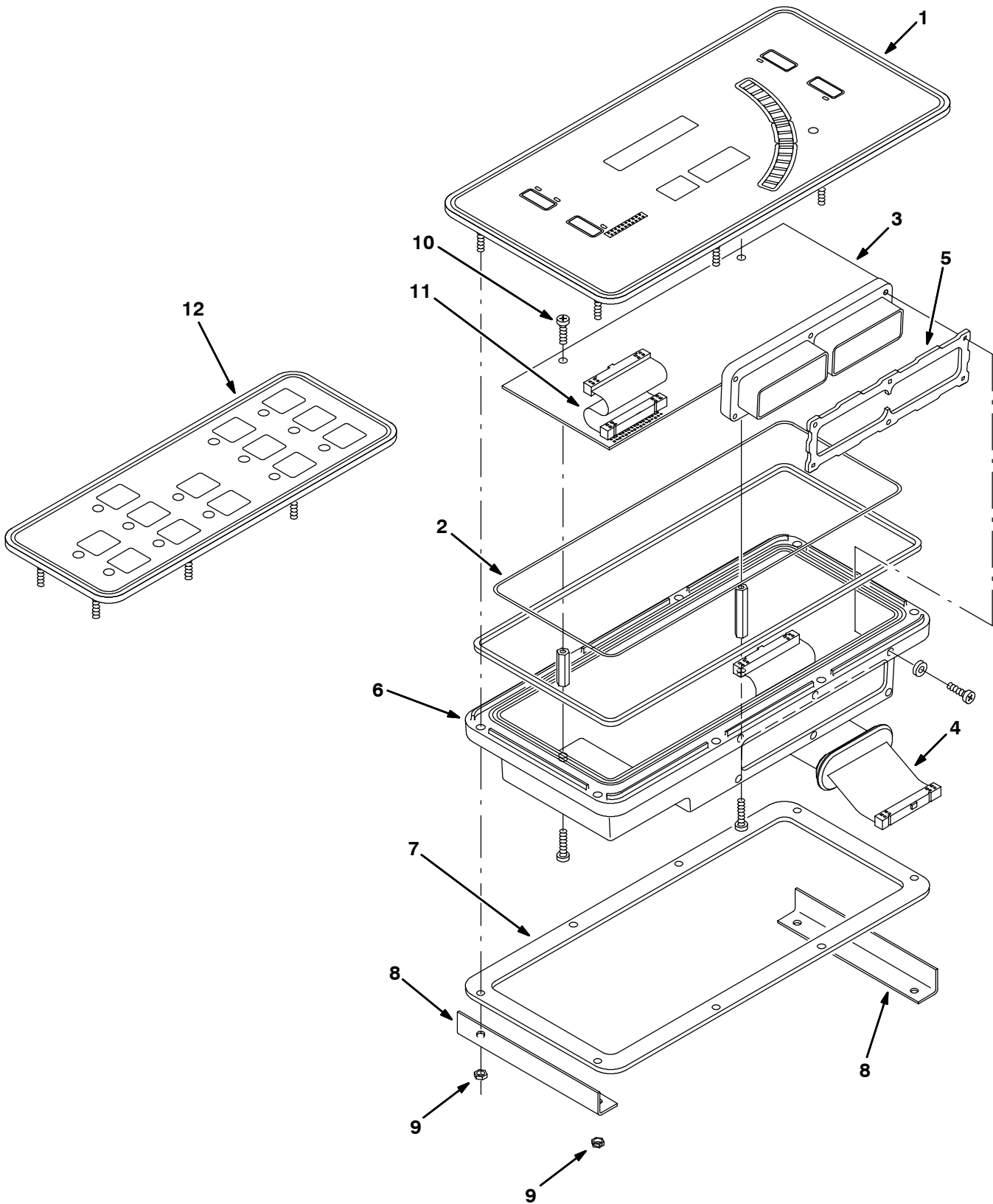

## CUMMINS 6 CYLINDER ENGINE BREAKDOWN

**Fig. 16 - Cummins 6 Cyl. Instrument Panel Assembly**

Ref.	Tennant Part No.	Machine Serial Number	Description	Qty.
▽	769325	(000000-	) Instrument Panel Assembly Emissions	1
▲	1 769326	(000000-	) Panel, IAssembly, Control, Emissions	1
▲	2 73219	(000000-	) O Ring Seal	1
▲	3 769327	(000000-	) Board Assembly Emissions	1
▲	4 768583	(000000-	) Cable, Ribbon, 34 Conductor	1
▲	5 364943	(000000-	) Seal, Connector, 60 Pin	1
▲	6 768584	(000000-	) Box, Instrument	1
▲	7 364941	(000000-	) Plate, Backing	1
▲	8 364292	(000000-	) Bracket, L	2
▲	9 02850	(000000-	) Nut, Hex	8
▲	10 32515	(000000-	) Screw, Pan	2
▲	11 768582	(000000-	) Cable, Ribbon, 20 Conductor	1
▲	12 768586	(000000-	) Panel, Touch	1

**Fig. 17 - Cummins 6 Cyl. Electrical Group**

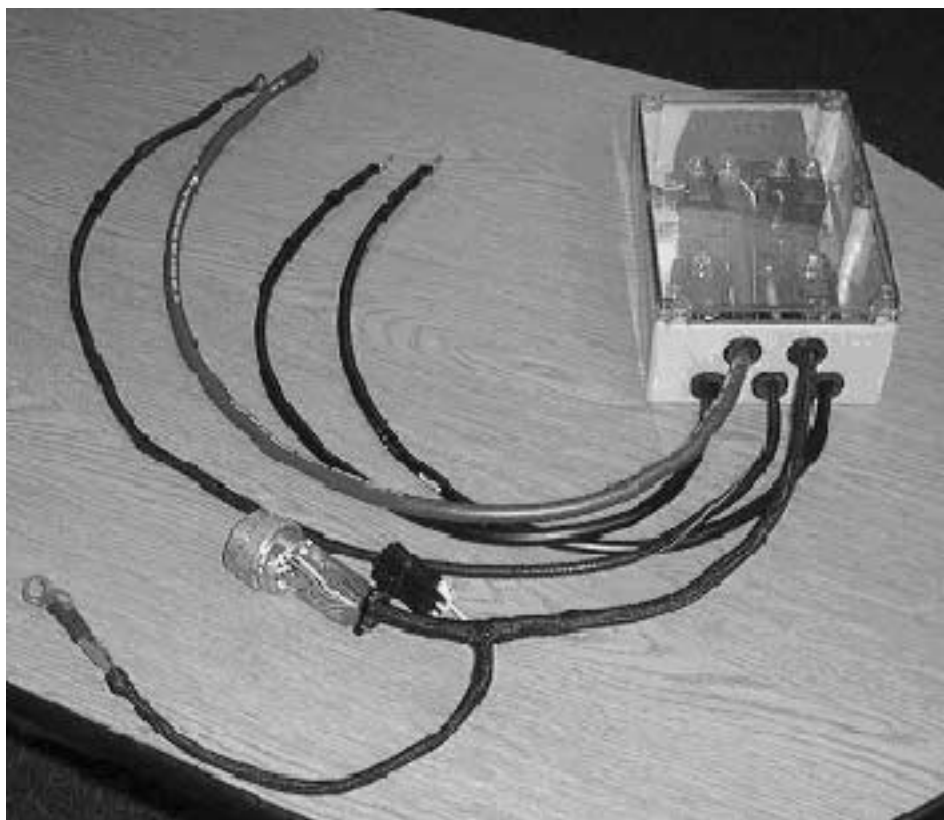
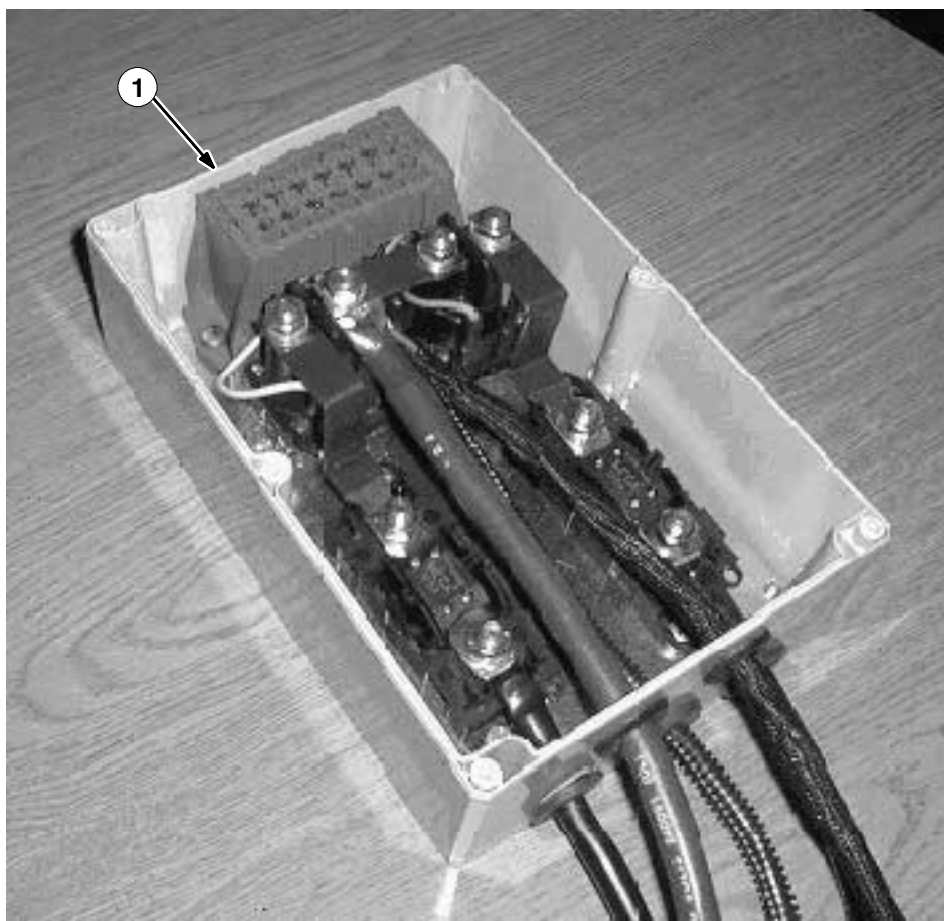

## CUMMINS 6 CYLINDER ENGINE BREAKDOWN

**Fig. 17 - Cummins 6 Cyl. Electrical Group**

Ref.	Tennant Part No.	Machine Serial Number	Description	Qty.
1	769209	(000000-	) Cummins ISB Pwr/Grid Assembly	1
2	383732	(000000-	) Contactor, 150 Amp	2
3	769242	(000000-	) Enclosure, Control, Emissions Engine	1
4	769251	(000000-	) Busbar, Contactor	1
5	769252	(000000-	) Busbar, Contactor/Fuse	2
6	769259	(000000-	) Panel, Mounting	1
7	769261	(000000-	) Fuse Holder	2
8	769262	(000000-	) Fuse 125 Amp	2
9	769263	(000000-	) Kit, Connector	1
10	769264	(000000-	) Connector, 23 Pin	1
11	769265	(000000-	) Kit, Backshell only	1
12	769266	(000000-	) Terminal, 14-16 Awg	4
13	769267	(000000-	) Terminal, 16-18 Awg	7
14	769268	(000000-	) Holder, Fuse	1
15	769269	(000000-	) Leg, Mounting	2
16	769270	(000000-	) Wedge, Locking	2
17	769271	(000000-	) Grommet, Small	2
18	769272	(000000-	) Grommet, Medium	1
19	769273	(000000-	) Grommet, Large	1
20	762534	(000000-	) Fuse 5A	1
21	762533	(000000-	) Fuse 7.5A	3
22	762513	(000000-	) Fuse 10A	2

# CUMMINS 6 CYLINDER ENGINE BREAKDOWN

Fig. 18 - Cummins 6 Cyl. Documentaion Group

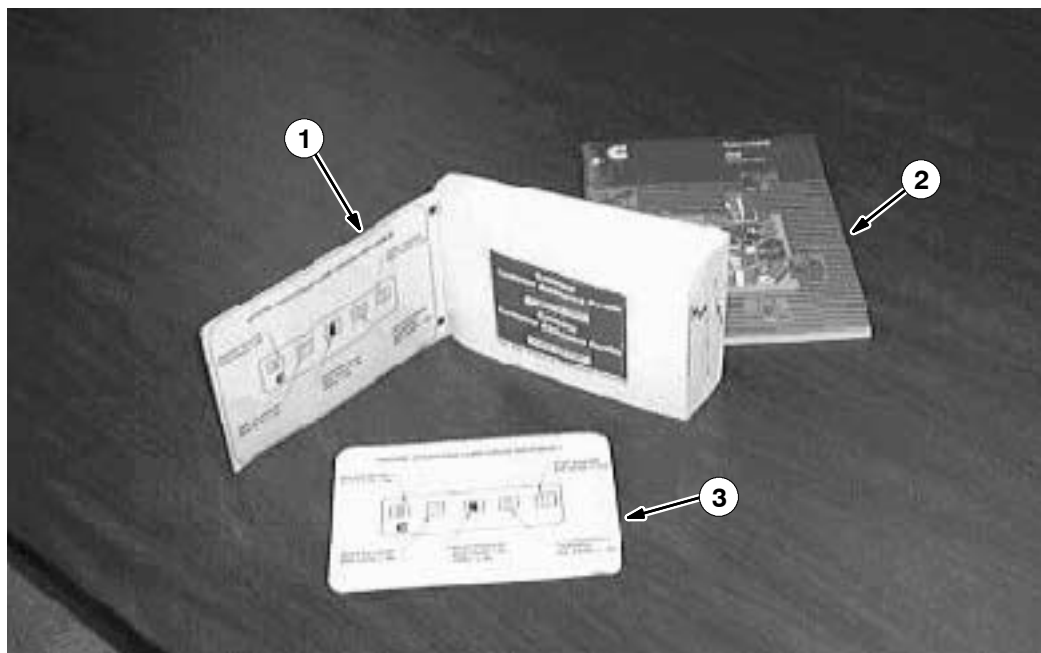

# CUMMINS 6 CYLINDER ENGINE BREAKDOWN

Fig. 18 - Cummins 6 Cyl. Documentation Group

Ref.	Tennant Part No.	Machine Serial Number	Description	Qty.
1	769306	(000000-	) Operation Manual, Cummins Engine	1
2	769307	(000000-	) Parts Catalog, Cummins Engine	1
3	769305	(000000-	) Label	1

